

25
YEARS

DOORS ARE

TOORS

INDY
INDUSTRIAL DOORS





DHL Czech republic



TESCO United Kingdom



Czech republic



MAN Czech republic



TESCO United Kingdom



Belgium

We develop doors both Industrial and Residential. 20 years of market experience can tell our story.

50+



RELIABLE DOOR PRODUCER

- Supplies to more than 50 countries worldwide
- Cooperation with renowned suppliers of door components
- Quality Management System, Automated Production and Quality Control
- Professional customer service, Complex door configuration

OPTIMIZED SOLUTIONS

- We design and produce doors according to standard/non-standard request
- Various possibilities of modification in non-standard cases: oversize, track deflection, track length, etc...



HSE (Health & Safety & Environment)

Certification according to EN 13241-1

Toors is significant member of **EDSF**
(European Door and Shutter Federation)



BASIC SPECIFICATION



Quality and safety of TOORS sectional doors is at the first place. TOORS sectional doors are produced from a quality materials and components, supplied by distinguished European suppliers. Complete process of production is countinously controlled to ensure customer's satisfaction, at all requests.

TOORS sectional doors fullfill Europen norms related to door technics and tested by harmonised norm EN 13241-1.

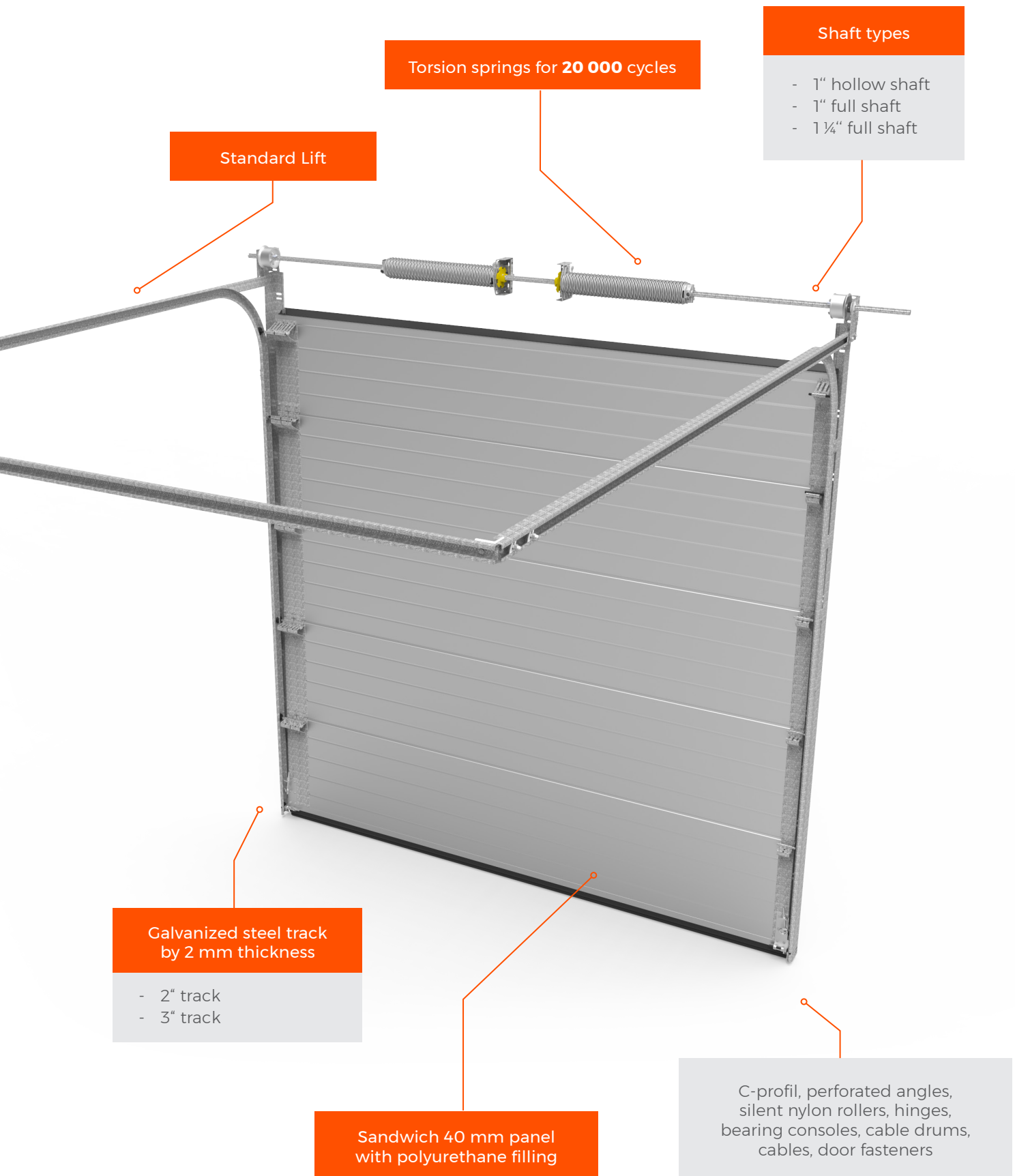

Standard Lift

Torsion springs for **20 000** cycles

Shaft types

- 1" hollow shaft
- 1" full shaft
- 1 ¼" full shaft

Galvanized steel track
by 2 mm thickness

- 2" track
- 3" track

Sandwich 40 mm panel
with polyurethane filling

C-profil, perforated angles,
silent nylon rollers, hinges,
bearing consoles, cable drums,
cables, door fasteners

LIFT TYPE

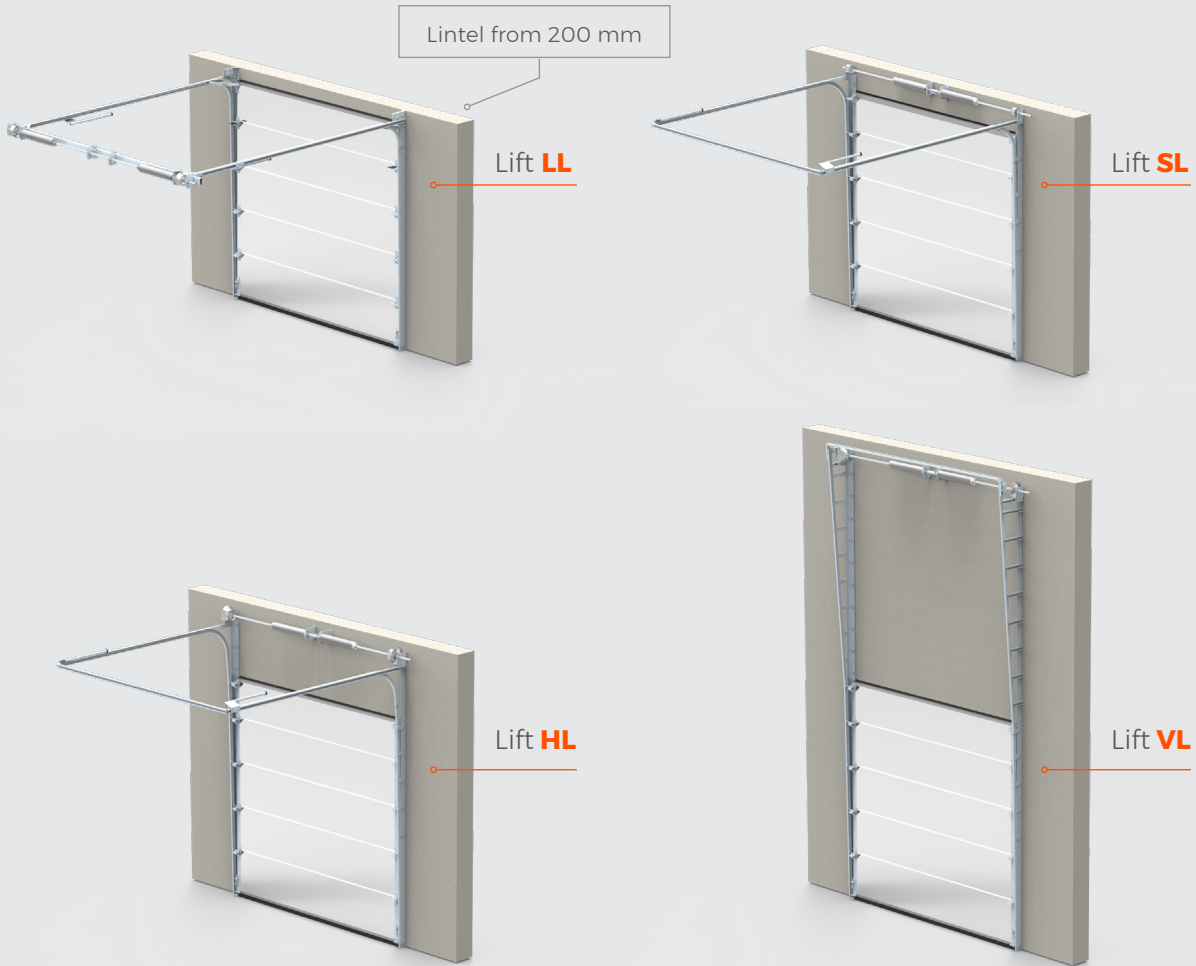

Lift Type	Subcategory	Min. lintel (mm)	Max. m ²	Max. dimension (mm)
LL - Low Lift	LL-DT	200	23 m ²	6 000 × 5 000
	LL-I	230	23 m ²	6 000 × 5 000
SL - Standart Lift	SL350	350	25 m ²	7 000 × 3 600
	SL420	420	40 m ²	8 000 × 6 500
HL - High Lift	HL	higher than 420, lower than 2x opening height + 400	40 m ²	8 000 × 6 500
	HL-1T	higher than 850, lower than 1450	16 m ²	4 000 × 4 000
	HL-2T	higher than 1450, lower than 3250	25 m ²	5 000 × 5 500
VL - Vertical lift	VL	opening height + 400 mm	40 m ²	8 000 × 6 500
	VL-T	opening height + 420 mm	25 m ²	5 000 × 5 500



FSL
Standart Lift under 15° angle

TRACK UNDER ANGLE

Horizontal track can be under angle copying the roof angle up to 45°.

DOUBLE ANGLED TRACK

Possibility of double angled track helps to conform any roof shape.

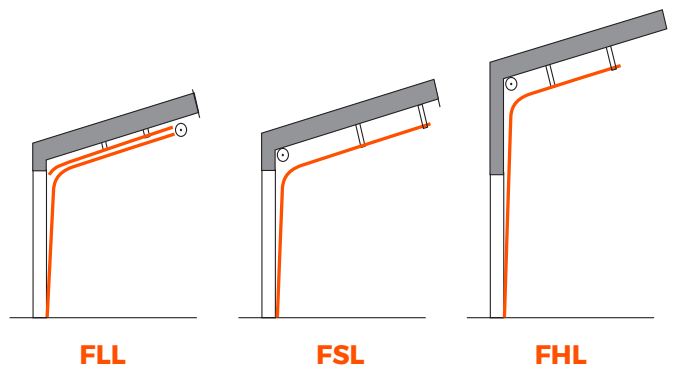



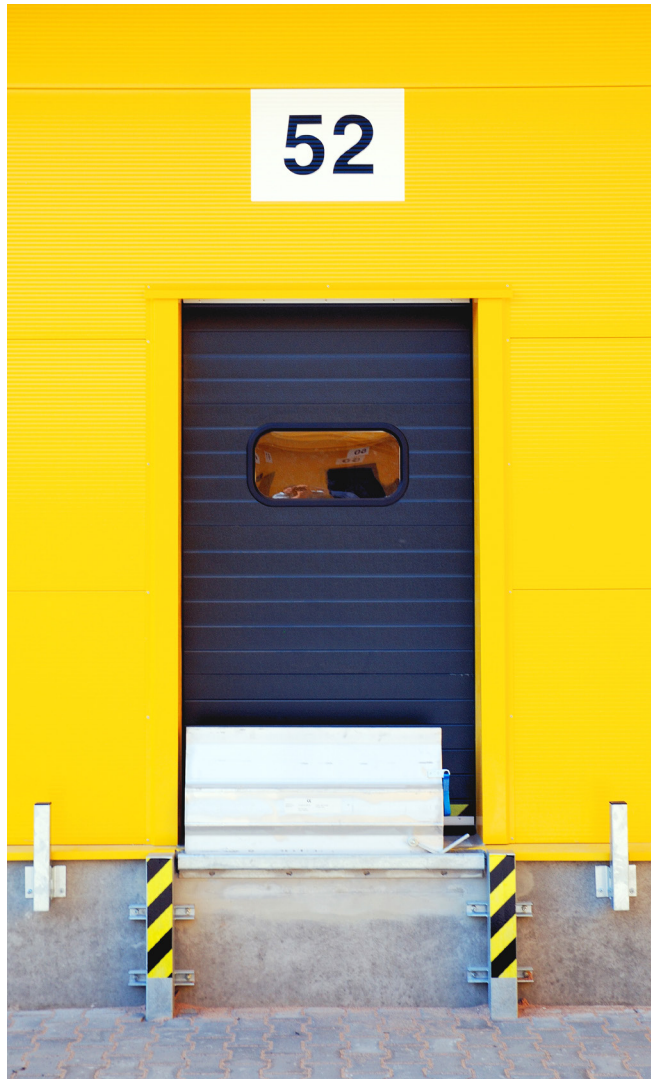

We aim to overhead door production.
At our disposal, we have top notch machinal
equipment and sufficient production capacity
to cover increasing demand.



Sandwich panel is made by two both-side galvanized steel sheets. In between, there is polyurethane foam, which performs thermal and noise isolation. Standard panel thickness is 40 mm, but we also offer 80 mm panel with better thermal and noise isolation. We offer panels by 40 mm in designs STANDARD and PROTECT (finger safe protection).

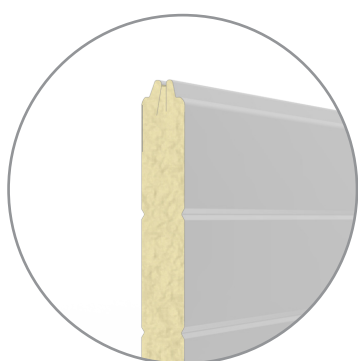

Standard 40 mm

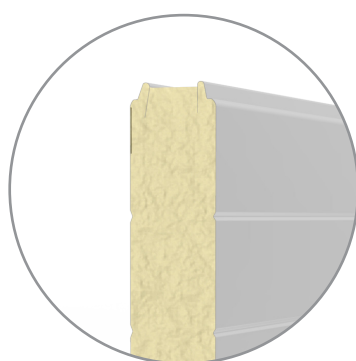

Standard 80 mm

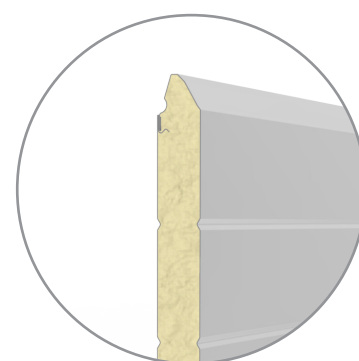

Protect 40 mm

DESIGN

DESIGN STANDARD

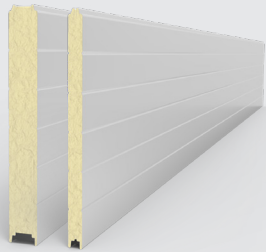

Surface structure

lamella stucco

Outside color

according to current panel range

Innerside color

according to current panel range

Traditional panel shape | Polyurethane foam core |
 Double-side hot dip galvanizing |
 U (40mm) = 0,50 W/m²K | U (80mm) = 0,27 W / m² K
 | R = 25 dB

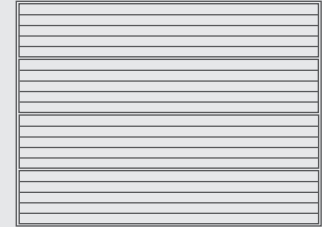

40 mm / 80 mm

DESIGN PROTECT

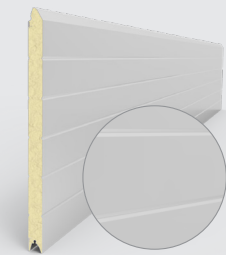

Surface structure

lamella stucco / lamella flat

Outside color

according to current panel range

Innerside color

according to current panel range

Finger safe protection (FSP) | Polyurethane foam core |
 Double-side hot dip galvanizing |
 U = 0,52 W/m²K | R = 25 dB

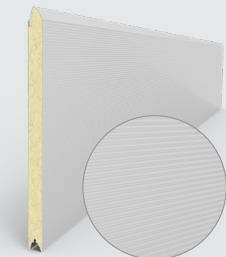

Surface structure

V-profile smooth

Outside color

according to current panel range

Innerside color

according to current panel range

Finger safe protection (FSP) | Polyurethane foam core |
 Double-side hot dip galvanizing |
 U = 0,52 W/m²K | R = 25 dB

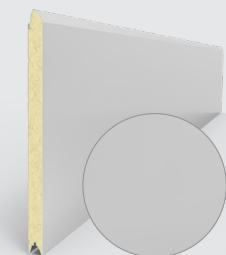

Surface structure

flat smooth

Outside color

according to current panel range

Innerside color

according to current panel range

Finger safe protection (FSP) | Polyurethane foam core |
 Double-side hot dip galvanizing |
 U = 0,52 W/m²K | R = 25 dB



ALUMINIUM FULLY GLAZED SECTIONS - FVE

TECHNICAL PREFERENCES

- Standard design with anodized aluminium frame E6/EV1
- Variable design for STANDART and PROTECT panel with and without broken thermal bridge
- Choice of different fillings depending on design, thermal insulation properties and air permeability
- Possibility of additional painting of aluminium frames to RAL, NCS, DB
- Anti- scratch

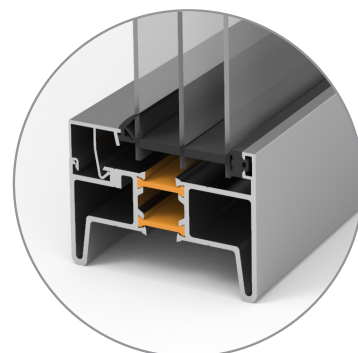

DESIGN
WITHOUT BROKEN
THERMAL BRIDGE

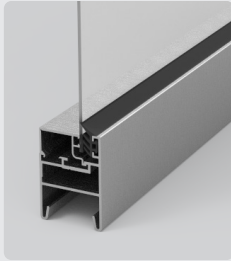

Single



Double



Stucco Filling

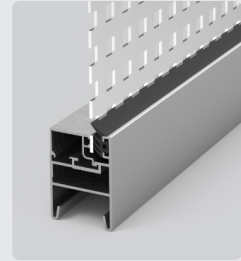

Aluminium
Expanded Mesh

DESIGN
WITH BROKEN
THERMAL BRIDGE

- For panels STANDARD and PROTECT (40 mm and 80 mm)
- Design identical with current fully glazed solution with finger save protection
- Excellent insulating properties (decreased heat permeability up to 22%)
- Stopped water condensation on innerside (Exterior vs Interior)



FVE TB - 40 mm

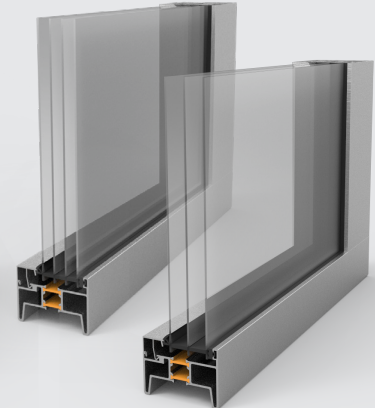

FVE TB - 80 mm

Example:

Design	FVE 40 mm	FVE TB 40 mm
Width	4 500	4 500
Height	3 500	3 500
Thermal permeability	3,8 W/m ² K	3,1 W/m ² K
Air tightness	3	3
Wind resistance	3	4
Water tightness	3	3

DECREASE
OF HEAT
PERMEABILITY
UP TO

22%

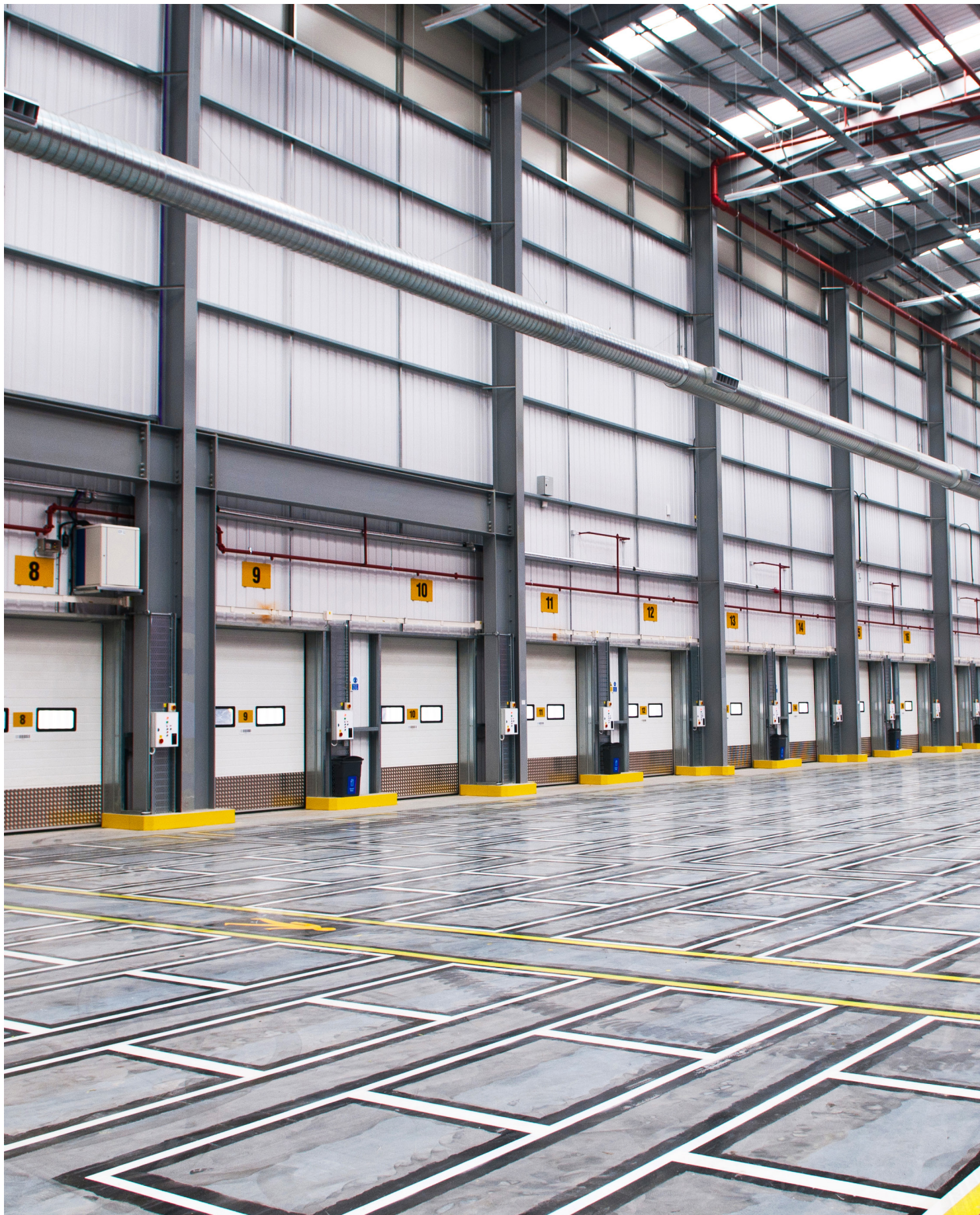



TOORS Indy doors you can find in production halls, logistics centers, car shows. Wherever needed to ensure flawless operations.

TOORS Indy doors provide high comfort of control, easy service and energy savings expended to heating/air conditioning of premises.

TOORS Indy doors meet the highest demand for operations.

PASS DOOR

TECHNICAL PREFERENCES

- Installation of pass door up to 30 m² door leaf
- Option to chose threshold- standard, low, extra low
- Anodized aluminium profiles E6/EV1
- Easy and fast installation
- Integrated steel reinforcement strut bellow door closer
- Possibility of additional painting to RAL, NCS, DB

THRESHOLD HEIGHTS

Section	Threshold	Height
Panel	Extra low	18 mm
FVE	Extra low	18 mm
Panel	Low	80 mm
Panel	Standard	225 mm
FVE	Standard	130 mm

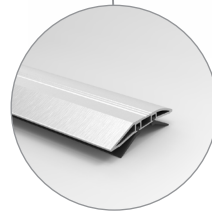

Extra low threshold

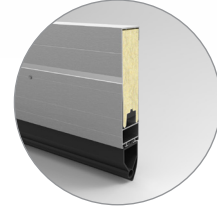

Standard threshold

BY USING EXTRA LOW THRESHOLD THE NORM OF EMERGENCY EXIT IS MET



PARAMETERS

Door height	1. - 4. section composition	Threshold	Handle height
2 300 mm	4 x 610 mm	Extra low	980 mm
		Standard/Low	1 030 mm
2 190 mm	3 x 610 mm 1 x 500 mm	Extra low	980 mm
		Standard/Low	1 030 mm
2 080 mm	2 x 610 mm 2 x 500 mm	Extra low	980 mm
		Standard/Low	1 030 mm
1 970 mm	1 x 610 mm 3 x 500 mm	Extra low	980 mm
		Standard/Low	1 030 mm
1 860 mm	4 x 500 mm	Extra low	870 mm
		Standard/Low	920 mm



ACCESSORIES

- Panic lock in various designs
- Electric lock
- Possibility of placed window or fully glazed sections

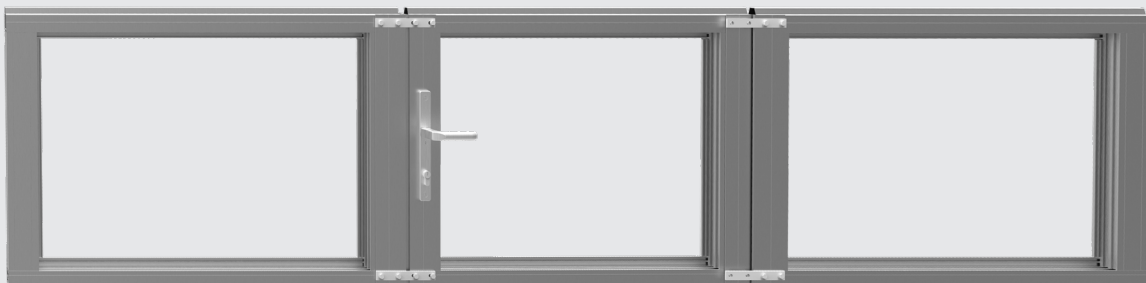

PARAMETERS

- Electronic limit switches
- Protection IP65
- Voltage 400V/230V
- Emergency operation by: chain (SK), declutching (ER)
- Opening speed 20-50 cm/sec
- Operator with Frequency Inverter



TOTMAN - Control Unit TS970

IMPULS - Control Unit TS970

- Optical features + 2pcs of cable break switch
- Spiral Cable/WSD Module + connection boxes

IMPULS + remote control - Control Unit TS971

- Optical features + 2pcs of cable break switch
- Spiral Cable/WSD Module + connection boxes
- Frequency 433 MHz



CUBE MOTORS

CUBE 50

- Industrialmotor
- Emergency chain operation
- Protection of bottom edge with light barrier incl. connection box and cable
- 24V DC Technology
- SoftStart and SoftStop function
- For doors with max. doorleaf area 12 m²

CUBE 70

- Industrialmotor
- Emergency chain operation
- Protection of bottom edge with light barrier incl. connection box and cable
- 24V DC Technology
- SoftStart and SoftStop function
- For doors with max. doorleaf area 20 m²
- Higher torque



MOTOR UNIT

- Readable two-digit display
- Easy operating
- Connection to all accessories
- Identical for both motors







TOORS Indy can contain aluminium fully glazed sections, except of attractive design, ensure better light conditions in halls or the fresh air access by using of special fillings.

Addition of TOORS Indy can be pass door together with low threshold, which meet the claims for emergency exits.

INDY GT-R HIGH-SPEED SECTIONAL DOOR

The impuls for development of this new product was overall greening of operational building features. INDY GT-R will show you, how easily meet stated requirements. By the combination of high speed (opening/closing) and excellent thermal insulating features, we get new unique generation of Industrial Door - INDY GT-R. Technical parameters are improved that much, so the door stand their native functions as much effective together with the best possible energy balance while using.

- + Thanks to higher speed of opening/closing there is possible faster passage through the door
- + Lower air circulation between outside and inside
- + Energy saving while heating or airconditioning

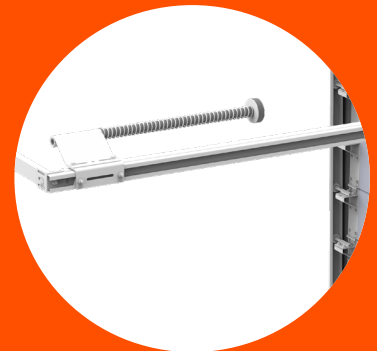
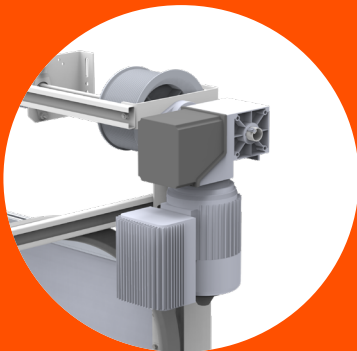

4X LOWER ENERGY LOSS
COMPARED TO CLASSIC
SECTIONAL DOORS

Newly developed massive components

- consoles
- bearings
- struts

Springs for 50.000 cycles

Hang on 1 1/4" shaft

Control unit with frequency converter

Silent spring bumpers

Light grid ensuring door safety

Parameter	INDY GT-R	INDY
Width	5 000 mm	5 000 mm
Height	5 000 mm	5 000 mm
Height of section	244-610 mm	610 mm
Maximum current opening speed	1,4 m/s	0,25 m/s
Panel thickness	40 mm	40 mm
Thermal permeability „U“	1,18 W/m²K	1,02 W/m²K
Opening/closing time	4 s	20 s





We look at industrial doors not just as an “invisible” part of production and storage halls, but as a quality and reliable product that allows entrepreneurs or business owners to focus on their ideas and plans instead of operational problems.

DEMANDING CONDITIONS

**We produce doors even
for extremely demanding conditions.**

Possibility of additional components
from stainless steel, paints for food industry
or reinforcing of construction to hard windy conditions.

USAGE:

- Wet surroundings
- Food industry
- Agricultural industry
- Aerial industry
- Navi

STAINLESS STEEL COMPONENTS

- Tracks
- End caps
- Hardware
- Spring bumpers
- Bottom bracket
- Wires

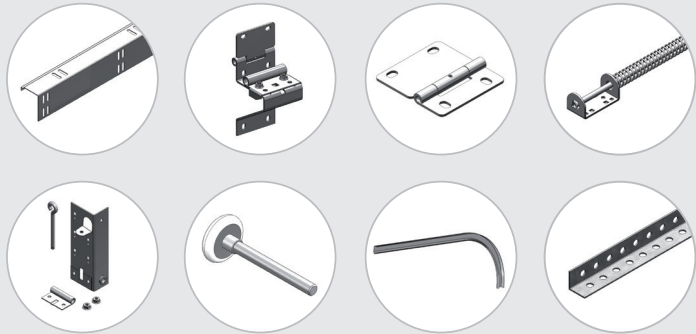



UNDERGROUND GARAGES

With use of industrial door operator with frequency inverter for high-capacity garages.

Optimum air permeability (56% / 67%)

Variability of control - key switch | remote control | traffic light | microwave radar | induction loop

- Wide range of accessories
- Control Unit TS981 for two-way traffic
- External photocells
- Pass Door with panic lock for need of emergency exit
- Up to 256 pcs remote controls can be used

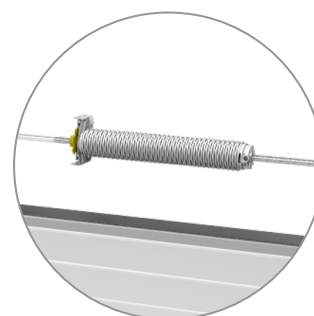

SPRINGS UP TO

150 000
CYCLES



BIM PROCESS

- Use for building of family houses up to logistics centers
- BIM segment technologies with advantage of our BIM patterns
- Patterns for industrial doors, residential doors and Mandoor
- Particular construction elements are described by 3D pattern data file (with properties)

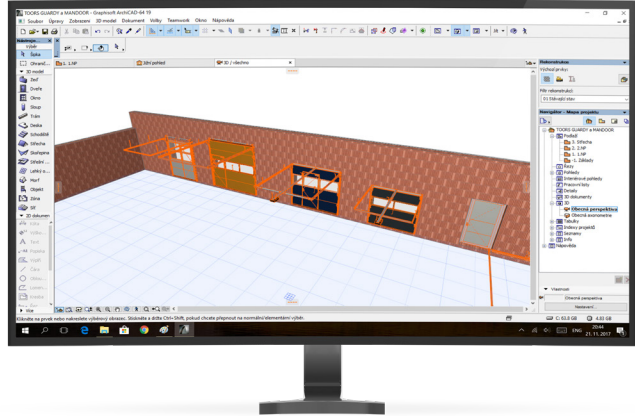

Download on www.bim.toors.com



BIM LIBRARIES

Our rigorously processed patterns increase probability of their further use, for example by architects or designers in comparison to currently lower quality patterns of the others, which do not meet the reality.

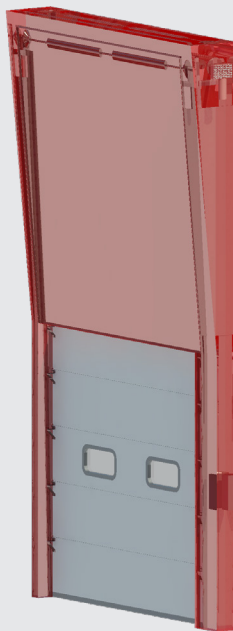

INDY
- industrial doors



GUARDY
- residential doors

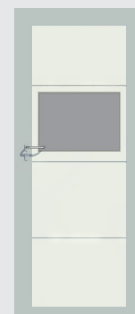

MANDOOR
- mandoor



DOOR CONFIGURATOR



sTOORe

Configurator of all door types- Industrial door, Residential door, Double Leaf door, Mandoor.

FUNCTIONS:

- Web interface available from PC, smart phone or tablet
- Fast and easy door specification
- Quotation immediately available for the end customer
- Requested documentation right on hand
- Overview of valid quotations and orders
- Visualisation of configured door

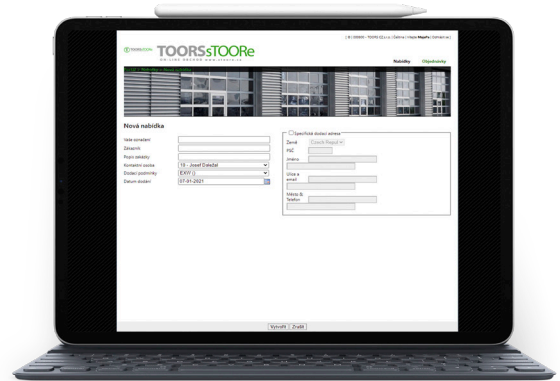

DOOR CONFIGURATION AT DISPOSAL
IN SEVERAL LANGUAGE MUTATIONS







TOORS Indy offer either endurance, functionality, certified safety and variable design.

TOORS Indy meet all the highest claims for operation and also fit to overall look of the building concept in parallel.

SPARE PARTS

WE CAN SUPPLY YOU WITH ANY SPARE PARTS

We bring a wide range of spare parts for your sectional garage and industrial door so you can keep your doors in optimum condition. We regularly update our range of spare parts to be compatible with a wide range of sectional doors, so you don't have to look elsewhere.

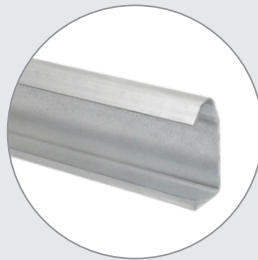
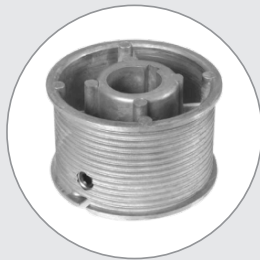

Spare parts and door accessories can be found on our online shop TOORS SERVICE.



MEASUREMENT PROTOCOL

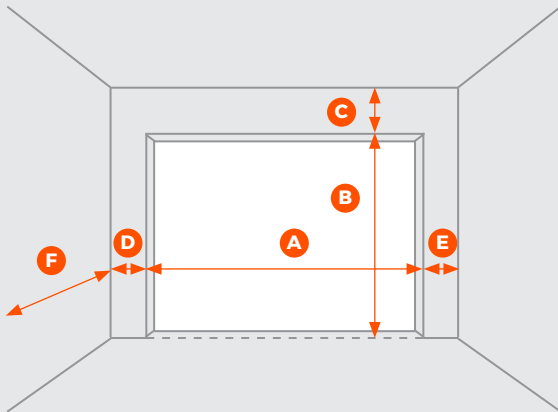

A - Width		mm.
B - Height		mm.
C - Lintel		mm.
D - Left side		mm.
E - Right side		mm.
F - Space Depth		mm.
Shaft Length		mm.
Angle		%

Door Parameters	Yes	No	Specification
Windows / FVE sections			
Panel design			
Fixed top panel			
Pass Door			
Handle and lock type			
Door operator			
Previous door removal			
Previous door disposal			
Forklift at site			

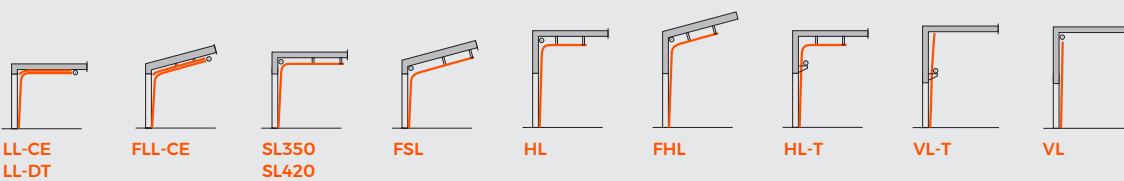

Customer address

.....

.....

.....

Name of the installer

.....

Note:

.....

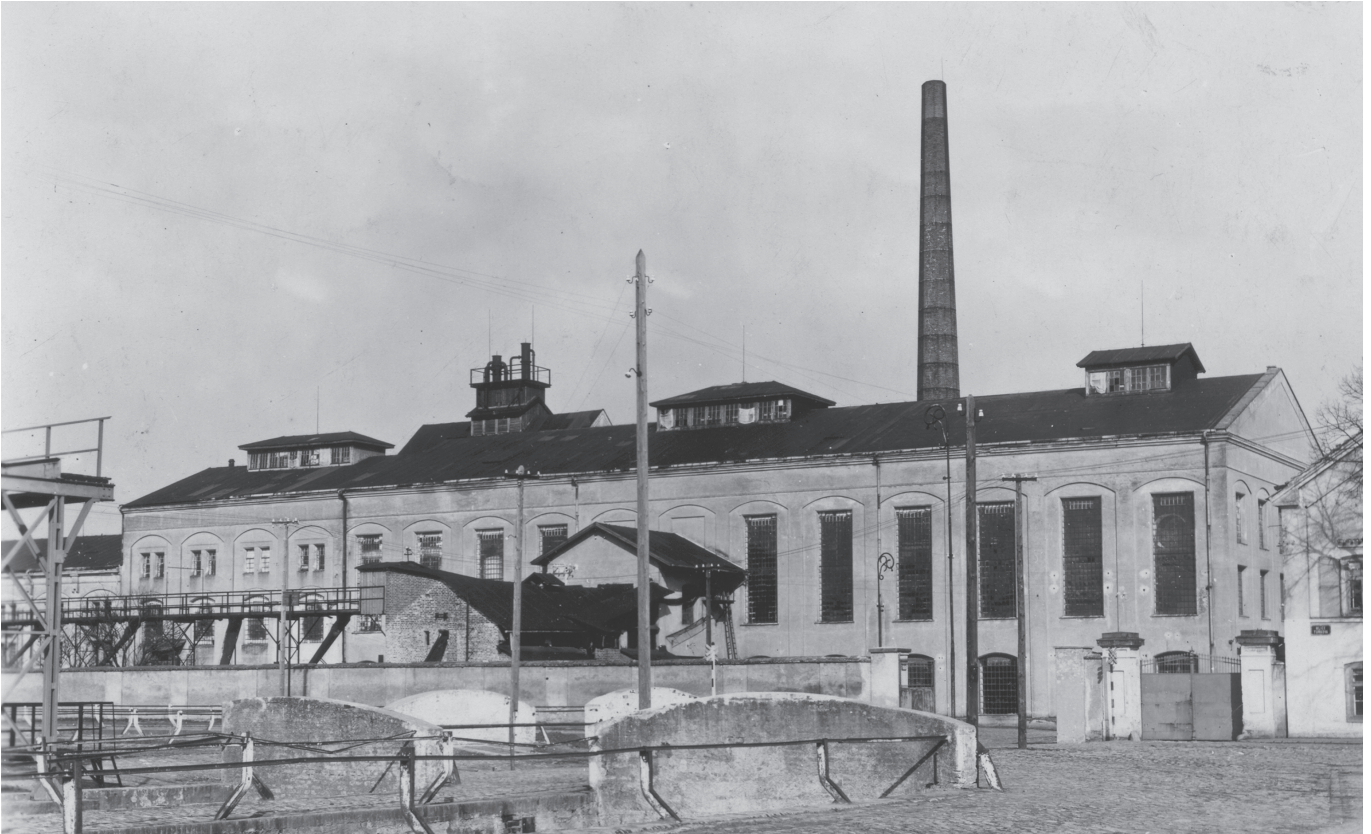

HISTORY OF TOORS

THIS IS WHERE IT ALL STARTED

It's been a quarter of a century we decided to build our business on respect to customers, suppliers, colleagues and others.

THIS IS WHERE WE PRODUCED OUR FIRST DOOR.

AND TODAY?

TOORS stands for great professionals in the European door industry. We are conquering the world slowly but surely.

GENERAL COMPANY DATA	
COMPANY ESTABLISHED	2 000
TURNOVER 2023	22 MIO €
DOORS PRODUCED 2023	20 000 PCS
DOORS TO BE PRODUCED 2026	36 000 PCS
EMPLOYEES	140
EDSF (European Door & Shutter Federation)	Since 2010
LAND AREA	18 000 m ²
PRODUCTION & WAREHOUSE	12 000 m ²
NUMBER OF COUNTRIES WHERE WE OPERATE	50+

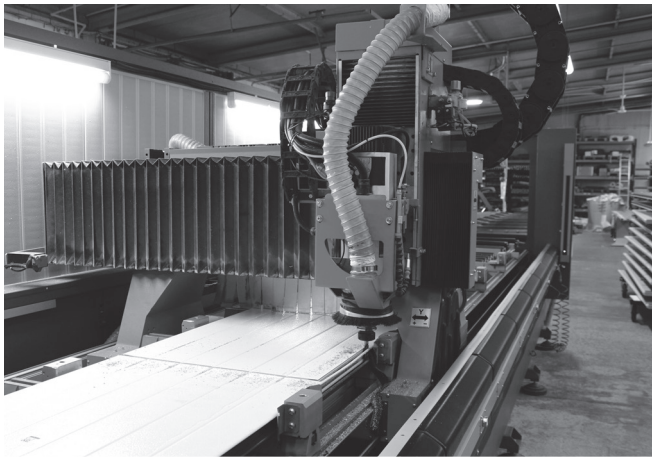

PRODUCTION CAPACITY
+30 000 PCS
 PER YEAR

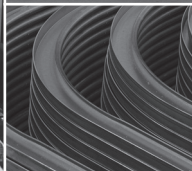

**DEVELOPMENT
 OF TOORS**

**THREE BASIC PILLARS
 OF TOORS COMPANY CULTURE**



EASY COOPERATION

- Friendly communication
- Minimum of bureaucracy
- Flexible and fast decision chain



LEAN THINKING

- Openness for changes
- Smart efficiency and cost savings
- Added value focus



FREEDOM WORKS

- Responsibility build freedom
- Respect and fair treatment
- Leadership and enthusiasm



TOORS CZ s.r.o.

Turkova 1338

504 01 Nový Bydžov

+420 495 491 855 | toors@toors.cz

www.toors.com

